



 **Strand**

C21 / EC21

ADVANCED TECHNOLOGY DIMMER RACKS

OPERATION GUIDE

NOTE: The material in this manual is for information purposes only and is subject to change without notice. Strand Lighting assumes no responsibility for any errors or omissions, which may appear in this manual. For comments and suggestions regarding corrections and/or updates to this manual, please contact the nearest Strand Lighting office.

PREFACE

Thank you for choosing Strand C21 / EC21 Advanced Technology dimmer rack. We trust that the equipment will meet all your dimming needs and will provide you with reliable service for many years.

Strand can assure you that every effort has been made to ensure that the equipment has been designed to meet the highest professional standards and that dimmer racks and their components have been assembled, inspected, and tested in accordance with our strict quality assurance program.

Should you encounter any problems or difficulties with your dimmer racks, please contact the nearest Strand service representative. For a complete list of Vari-Lite offices and service centers or visit our website (www.vari-lite.com).

This manual describes the operation of for C21 / EC21 Advanced Technology dimmer racks. A separate Installation Guide provided with the dimmer racks describes how to install the dimmer racks and perform initial setup procedures.

TECHNICAL ASSISTANCE

C21 / EC21 racks and dimmers require a minimum of maintenance and servicing.

For operation or technical assistance, please contact Vari-Lite or the local Authorized Service Center serving your area.

DEFINITION OF TERMS

This manual uses the following terms throughout:

channel	A device controlling a dimmer or group of dimmers. Historically, there is a physical controller (such as a slider) for each channel. On most current control systems, channels are numbers accessed by a numeric keypad. Each channel can control multiple dimmers.
circuit	A connection device and wiring for powering a lighting fixture from a dimmer.
circuit ID	A unique six-digit numeric identity which you can assign to each dimmer. The circuit ID may be the same as the dimmer number, or may be a number used to indicate circuit location, phase, channel number, etc. This feature is useful for tracking all circuits in the architecture.
crossfade	A fade that contains both an up-fade and a down-fade, or any fade where the levels of one cue are replaced by the levels of another cue.
cue	The process of recalling a preset from its memory location and putting the result on stage. Preset, Memory, and cue are often used interchangeably.
curve	The relationship between a control level and the actual dimmer output.
dimmer	A device controlling power to a lighting fixture. Two lights on the same dimmer cannot be separately controlled.
default	The original factory settings.
DMX512	An ANSI communications protocol standard that describes a method of digital data transmission between controllers, lighting equipment and accessories.
Ethernet	A high-speed network based protocol used to transmit data from a lighting controller to a dimmer rack using a single Ethernet cable.
fade	A gradual change in stage levels from one set of intensities to another.
fade time	The time it takes for dimmer levels to go from their current levels to the levels in the selected preset, or DMX512 value. Each preset has its own fade time.
IGBT	Insulated Gate Bipolar Transistor. IGBT dimmers are solid-state and operate silently without the use of chokes and can handle a variety of load types. They reduce lamp filament noise during dimming operation, are smaller, lighter, and generate far less neutral harmonics than conventional dimmers. IGBT dimming technology provides superior overload and short-circuit protection and operates at significantly higher rise/fall times regardless of load size.

level	A numerical value used to express the “brightness” of the load on a dimmer. Usually shown as %.
patch	Historically, the process of physically connecting circuits to dimmers. Now usually refers to electronic assignment of dimmers to channels.
phase	The three phases of the mains supply to which the dimmers are connected are identified as Line 1, Line 2, Line 3 in 230v markets and as phase A, phase B, and phase C in 120v markets.
power module	A chassis containing one, two or four dimmer or contactors. This is sometimes referred to as a “dimmer”. However, each C21/EC21 power module can have multiple dimmers or contactors in it, so this manual distinguishes between dimmers (individual power control circuits) and power modules (a collection of one or more power control circuits).
preset	A pre-defined setup of intensities for a set of channels, stored in memory for later replay.
preset fade time	See fade time
profile	The relationship between a control level and the actual dimmer output. Also known as “dimmer law” or “curve”.
rack number	A number used to uniquely identify each dimmer rack in a multiple rack system. Rack numbers are set from the front panel of the rack processor module, and are usually set by the installation engineer.
room	An area separately defined for purposes of architectural lighting control. This is usually a room in the traditional sense (an indoor enclosed area) or a portion of a room that can be partitioned off. Each room may be separately and simultaneously controlled by the system.
RPH	rack processor housing
RPM	rack processor module
SSR	solid state relay) A power control device used in Strand dimmers that contains two silicon control rectifiers (SCRs), control circuitry, and optical isolation circuitry.
Vision.Net	A digital architectural control system for use with C21/EC21 dimmer racks.

GENERAL

This manual describes the operation and setup of the dimmer rack. It does not contain information about installing the rack. See the separate C21 or the EC21 Dimmer Rack Installation Manual for detailed information concerning installation and wiring of the dimmer rack.

SPECIFICATIONS

For the latest specifications for C21 / EC21 dimmer racks and dimmer modules, refer to the product datasheets available for download on the website at www.vari-lite.com.

RACK COMPONENTS

The C21 / EC21 dimmer rack is a listed, free standing, factory assembly of steel and aluminum construction finished in a fine textured, scratch resistant coating.

Each C21 / EC21 dimmer rack consists of a rack processor housing (RPH) with one or two rack processor modules (RPM), a fan module, and up to 24 or 48 dimmer modules. The dimmer connectors at the back of the rack provide for load wire connection. Main bus bars are provided for line wire connections. An earth ground lug is provided in the rack. The dimmer connectors in the rack are polarized to prevent dimmer modules being plugged into the different ampacity slots. The dimmer racks can be individually fed or bused together using an optional busing kit.

Large dimmer racks have provision for up to 48 dimmer modules. Small dimmer racks have provisions for up to 24 dimmer modules. Dimmer modules contain one, two or four dimmers, and dimmer module types can be mixed within a rack in various combinations.

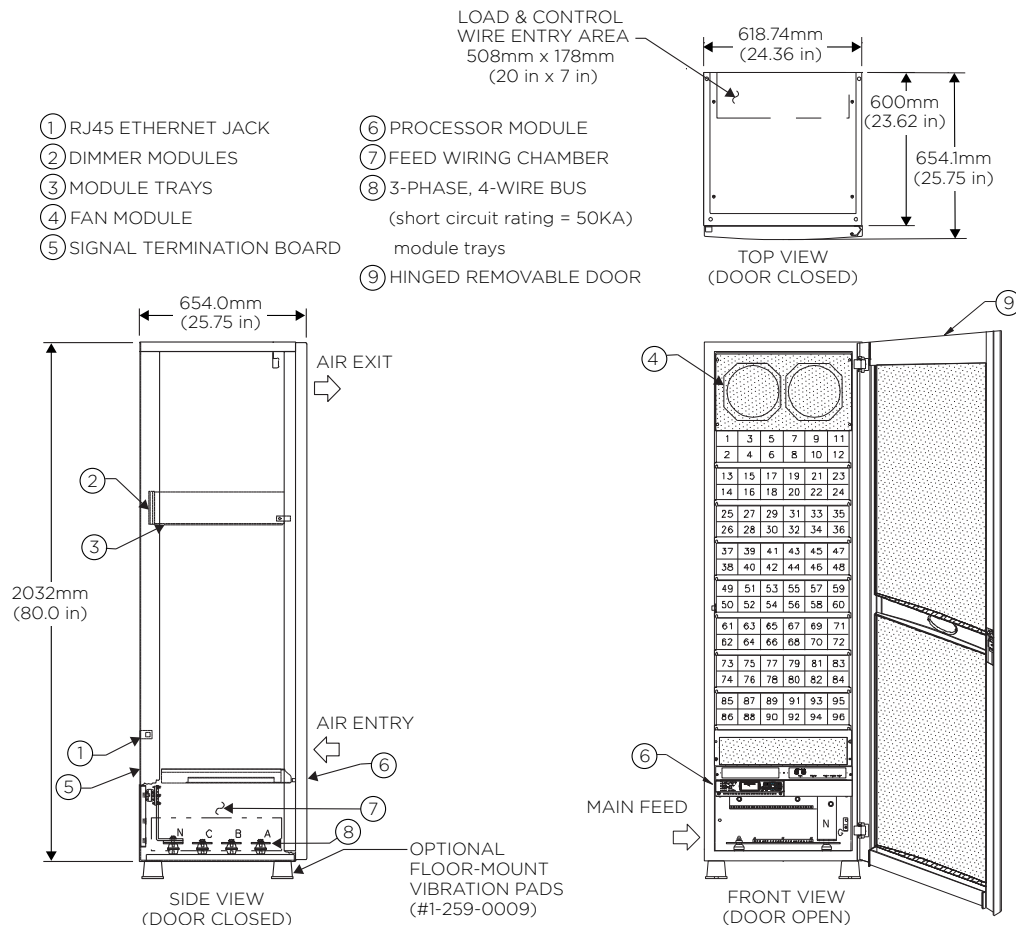

FIGURE 1. C21 / EC21 DIMMER RACK FULLY POPULATED

DIMMER MODULES

The power modules are the high power switching section of the C21 / EC21 dimming system. The power block in this module is the interface between the high power AC and low power control. It is driven by low level sig-

nals (5mA, 3-24V) and switches high level signals (up to 100A, 120/240VAC). High specification filtering, SCR dimming, contactor non-dims, IGBT dimming, and load status reporting electronics are available as options. Dimmers can be mixed in any combination in a rack. This lets you use the exact dimmer type needed for each circuit.

Power modules are constructed from aluminum, folded to form three sides of the dimmer and to support the dimmer connector and heatsink. The fourth side of the dimmer is formed by the heatsink. The top and bottom of the dimmer are open for cooling.

A sturdy handle is provided below the circuit breakers. An optional mechanical locking bar on the dimmer tray

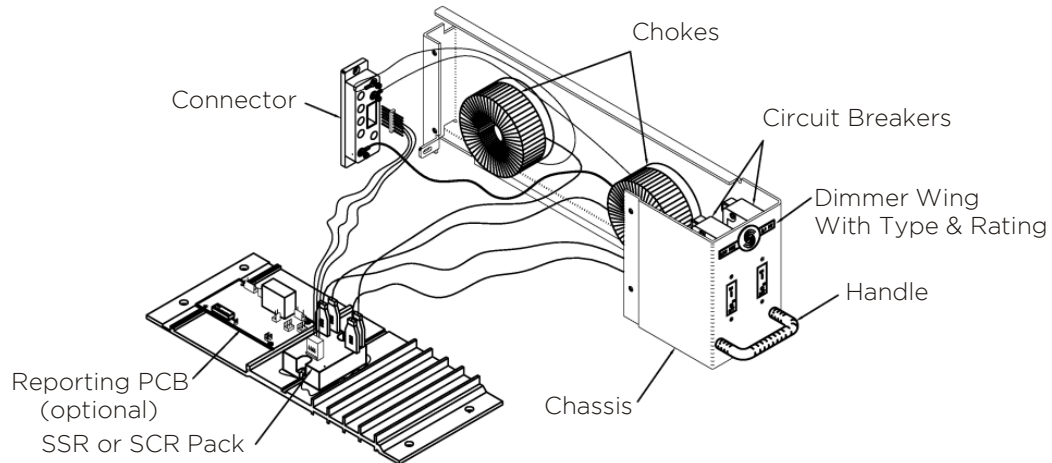

secures the dimmers in the rack.

FIGURE 2. DUAL DIMMER MODULE

REPORTING DIMMER MODULES

Most C21 / EC21 dimmer modules are available in load status reporting versions. Load status reporting versions of dimmers can be mixed in any combination with standard dimmers in C21 / EC21 racks. These dimmers report many dimmer status items back to the processor. The information can be accessed through various menu items. The processor can then display a wide range of faults and diagnostic data.

Each Reporting dimmer module contains a temperature sensor which will shut it down if it overheats. Anything causing overheating in the rack will cause a gradual shutdown as each Reporting dimmer module overheats.

IGBT DIMMER MODULES

C21 / EC21 IGBT electronic dimmers provide users with exceptionally quiet and efficient dimming for a wide range of loads. Each IGBT dimmer features forward and reverse phase control operating modes suitable for dimming incandescent and low voltage loads as well as a broad range of LED loads.

All C21 IGBT dimmers offer low insertion loss and microprocessor controlled over current and short circuit protection. Resetting the dimmer to zero percent (0%) from the control system will restore operation in the event of a module shutdown.

WARNING: Make sure that the neutral wire is landed correctly with its corresponding load wire for proper operation (see the C21 or EC21 Installation manual for more information). Failure to do so will cause the dimmer module to shut down.

Since the IGBT dimmer module monitors the dimmer rack power feed at all times, it is imperative that the power feed is clean and free of any distortion.

In the presence of poor quality power with significant mains disturbances, the IGBT dimmer module may shut down to protect the IGBT power devices.

IGBT dimmer modules should be configured as “Sinewave” module types when configuring the C21/EC21 dimmer rack processor.

IGBT DIMMER MODULE SWITCH PACK

The DIP Switches located at the side of the IGBT dimmer module allow for configuration of dimmer options.

NOTE: Dual-channel modules have a separate switch pack for each channel.

CONTROL MODE - (Factory Default ON) (Factory Default: Force FPC) Dimmer racks must be operated under normal conditions with all dimmers configured to Force FPC. If directed by Strand Technical Support, changing this switch to the AUTO mode position will allow the dimmer to automatically sense the load type and select either Reverse Phase Control or Forward Phase Control, based on the load's behavior. AUTO mode should be used only when a load does not operate properly in the default Force FPC mode.

RPC LOCK (LED) - (Factory Default: Normal) When used in combination with CONTROL MODE = AUTO, setting this switch to the Force RPC position locks the dimmer into reverse-phase-control only operation, which may be required for certain LED loads. Always set this switch to Normal in all other cases.

TRANSITION CONTROL - (Factory Default Automatic) Automatic operation allows the IGBT dimmer to monitor and adjust its transition control (up to 1000uS in 120V installations, and up to 650uS in 230V installations) based on several operational factors. The "Fixed at 400uS" position should ALWAYS be used when the dimmer is operating a phase-controlled electronic ballast or LED driver as its load, because these devices expect fixed transition times for proper dimming level selection.

FULL OUTPUT VOLTAGE - (Factory Default: 120V / 240V) These switches select the RMS output voltage to be delivered by the dimmer when the control level is 100%. Choose a non-default value if lamps of a lower voltage rating (e.g., 115V on 120V) are used in the lighting rig.

PREHEAT - (Factory Default: Preheat Disabled) When changed to the non-default position (Preheat Enabled), the dimmer will generate a very low voltage to the loads, when they are "off", to keep the filaments heated, improving response time. This feature should only be enabled on larger-wattage, incandescent lamps and only when faster turn-on response is required.

CAUTION: It is never recommended to set the switches to Reverse Phase Control (RPC) for an entire rack of

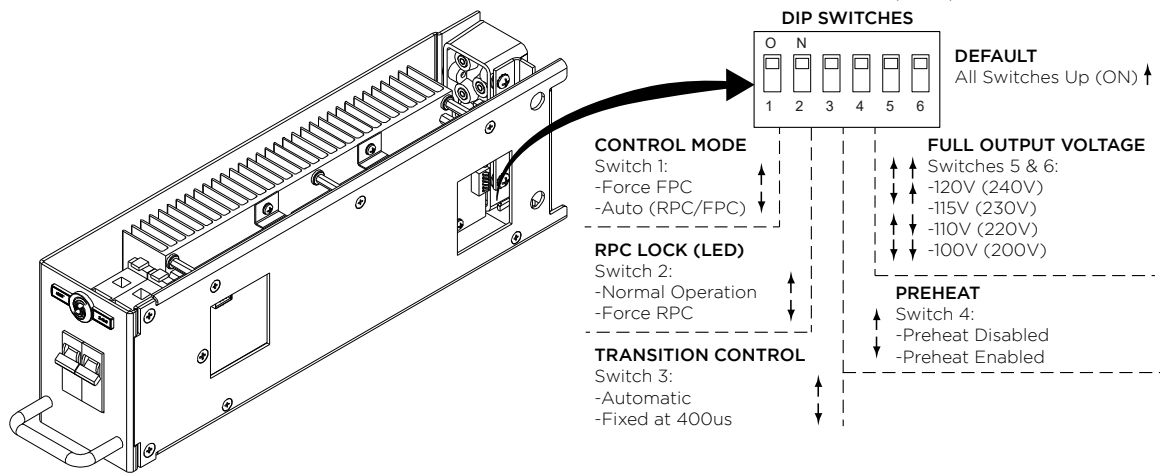

IGBT modules.

FIGURE 3. DIP SWITCH SETTINGS

FAN MODULE

C21 / EC21 dimmer racks are cooled by one or two low-noise variable speed fans in a fan module inside the rack. The cooling system is designed to let the rack continue functioning if any one of the fans fail. Cooling air is pulled up through the dimmer stack and exhausted through venting at the top of the rack. These fans are for dimmer cooling only, and can be set to fixed or variable speeds.

The fixed speed fan setting is for situations where changes in ambient noise are a problem. With this setting, the fans are always ON when the dimmer rack is in operation.

The variable speed fan setting minimizes noise and maximizes fan life. With this setting, the fan speed is adjusted so that fans reach full when 24 dimmers are at full, or equivalent (e.g., 48 dimmers at 50%). Increases in fan speed take 1 minute with this setting, while decreases in fan speed take 5 minutes. Fans are turned OFF when no dimmers are in use.

Fan and dimmer module choke noise may be acoustically objectionable. C21 / EC21 dimmer racks should be installed away from performance, stage and audience areas.

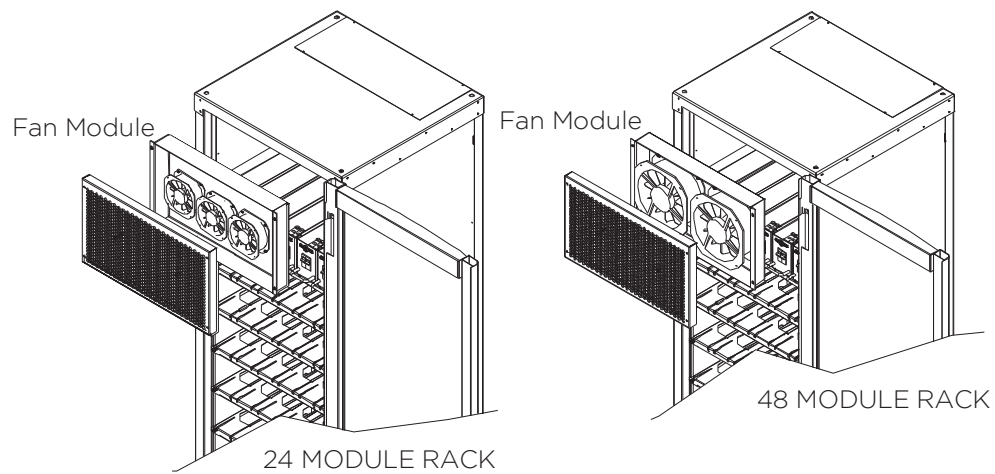

FIGURE 4. FAN MODULE

RACK PROCESSOR HOUSING

Each C21 / EC21 dimmer rack contains a rack processor housing (RPH) with all of the control electronics for the rack. This RPH contains the processor module(s) (RPM), control station power supplies, and control interconnection card (CIC) for the rack, and is shipped separately from the rack to minimize the possibility of damage.

This chassis can be equipped with one or two processor modules. The second processor module acts as a backup. The configuration data from either processor can be transferred into the other processor. The currently inactive processor always tracks the currently active processor.

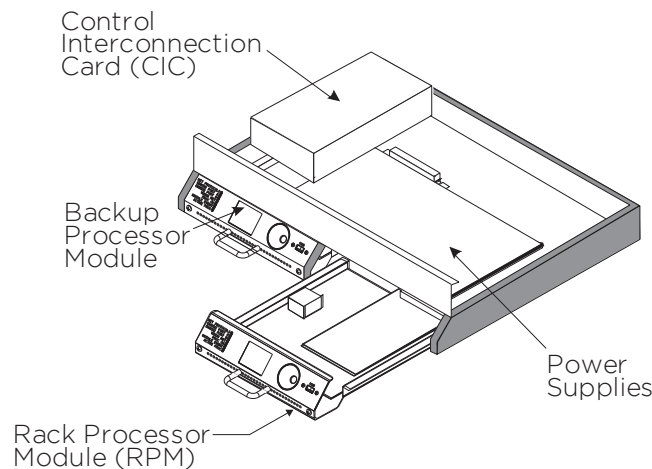

FIGURE 5. RACK PROCESSOR HOUSING

RACK PROCESSOR MODULE

Each C21 / EC21 dimmer rack contains one or two rack processor modules (RPM). Each processor module has a backlit LCD display, a 7 key keypad, and 6 LEDs to report processor module and dimmer status and allow setup and control at the rack. In normal operation, this display normally shows the rack name and the OK message. If there are any rack or dimmer events reported, the display will show error messages.

Pressing the < or > keys will takes you into a series of setup menus to view and set up the more frequently used C21 / EC21 features. See Section 3, Processor Module Programming for details on accessing these functions.

All programmed data is held in battery maintained RAM for up to 6 months without power.

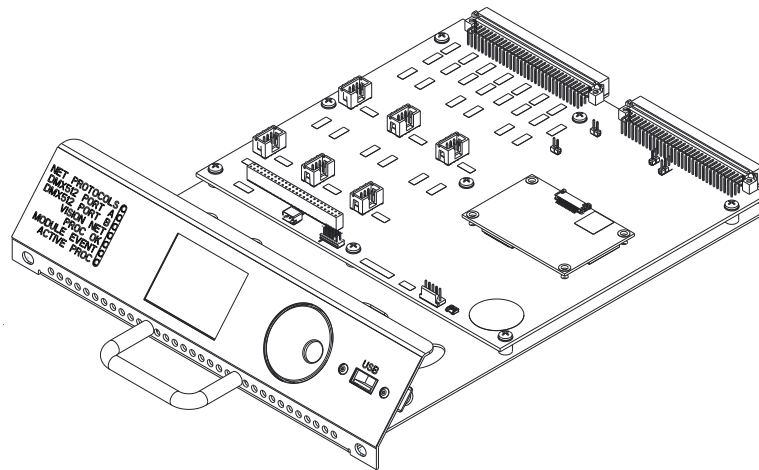

FIGURE 6. RACK PROCESSOR MODULE

POWER SUPPLIES

Each C21 / EC21 dimmer rack can have up to three power supplies, depending on the accessories provided. These power supplies are mounted on the rack processor housing.

CONTROL INTERCONNECTION CARD (CIC)

The electronics chassis also contains the control interconnection card (CIC). This is where the contractor terminates all control wiring for the rack. All control terminal strips are 2-part plug-in strips so that the electronics chassis can be easily removed from the rack.

PROCESSOR CONFIGURATION

Once you have applied power you need to make sure that the system is working correctly and the processor modules are set properly for the installation. This step checks for any problems due to shipping or installation.

Startup

When the rack is switched ON, a number of self-tests are run. The system displays the rack name.

When the self-tests are complete the PROCESSOR OK LED on the front of the processor module will turn ON, and the default text will show on the LCD display.

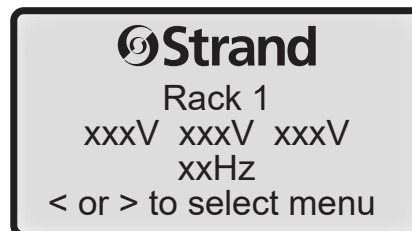

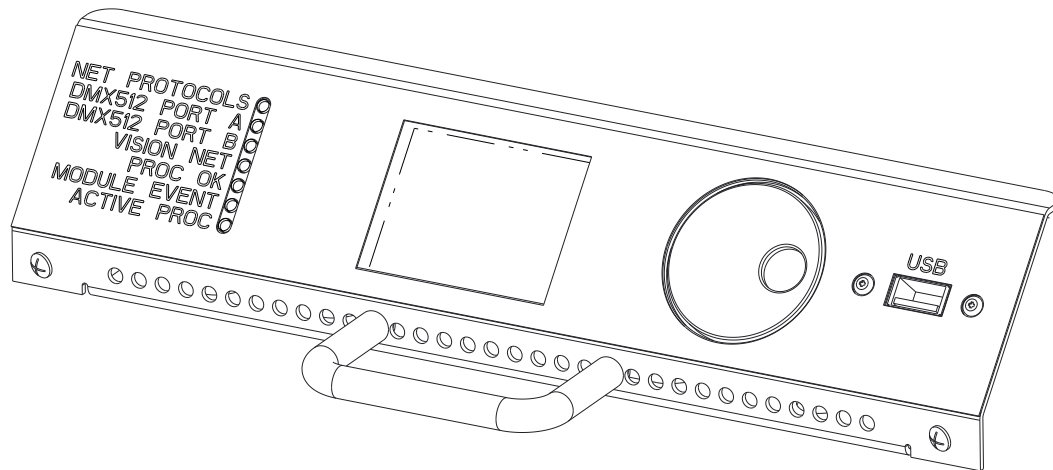

FIGURE 7. PROCESSOR MODULE FRONT PANEL

NOTE: If the MODULE EVENT LED is ON, check the dimmer event log to see which dimmer is causing problems. If any other LED does not illuminate correctly, switch OFF the power immediately and check the installation again. If all wiring seems correct, call Strand or your local Authorized Service Center.

LED STATUS

The LEDs on the front of each rack processor module are the first level of diagnostics and provide immediate visual status indication. The nine LEDs on the front of the rack processor housing and module indicate the following:

Rack Processor Housing LEDs

Phase A (green):	Should be ON if PhaseA/Line 1 is OK.
Phase B (green):	Should be ON if Phase B/Line 2 is OK.
Phase C (green):	Should be ON if PhaseC/Line 3 is OK.
Over-Temp (red):	Should be OFF. Flashing indicates an Over-Temp condition. ON indicates dimmer module automatic Over-Temp shutdown.
Panic (red):	Should be OFF. On indicates that PANIC has Been activated.
Lighthouse (blue):	Blue = normal. Flashing red = error. Solid red = shutdown.

Rack Processor Module LEDs

Network Connection (green):	Should be ON if there is a network signal.
DMX512 A (green):	Should be ON if there is a DMX512 signal.
DMX512 B (green):	Should be ON if there is a DMX512 signal.
Vision.Net (green):	Flashes ON when there is a Vision.Net signal.
Module Event (red):	Should be OFF. On indicates a dimmer fault
Processor OK (green):	Should be ON. Off indicates there is a problem.
Active Processor (green):	Should be ON if self-test is OK. Indicates active processor.

Dimmer Events

If the Module Event LED is on, the LCD will show the number of dimmer events at which time the display can be manually accessed to show a description of the event(s). Refer to the appendices section of this manual for a description of event codes. If any other LED does not illuminate correctly, switch OFF the power immediately and check the installation again. If the fault persists and all wiring seems correct, call Vari-Lite or your local Authorized Service Center (www.vari-lite.com).

After Startup

1. Check the following items to make sure they are correctly set in the processor module:

- Rack type
- Phasing
- Starting multiplex signal number and dimmer protocol
- Input Voltage
- Dimmer numbering

Other items you may wish to check at this time, depending on your system configuration, are:

- Mux patch
- Outlook patch
- Max Voltage
- Min Level

2. Switch on all load circuit breakers.

3. Connect a suitable luminaire to each outlet and check every dimmer using the SET LEVEL control facility or a suitable control console. Investigate and correct any malfunctions you find.

NOTE: If any dimmers do not work, stop and check the slot type for the dimmer. Dimmers will not work properly if their slot type is incorrectly assigned. Make sure that all of the modules are in their correct slots, and that the slot type for each dimmer is correctly set in the processor module.

4. Install the fan grill and door to complete the system installation.

OPERATIONAL FEATURES

RACK CONFIGURATION

The following configuration items are usually programmed during commissioning, but can also be reprogrammed by the user.

- Rack name.
- Panic selection and configuration.
- Maximum output voltage (per dimmer): 20-250 volts (e.g. set to 105V for extended lamp life).
- Minimum level (per dimmer): 0% - 100% (e.g. set to 10% for aisle lights or large lamp preheat).
- Room and channel Patching.
- Each dimmer can be patched to any valid DMX512 address number for the standard input A (DMX512 A), input B (DMX512 B) or network.
- Circuit ID—used by status reporting software.
- Define Preset Number or “Hold” condition on DMX512 failure.
- Define power-up preset.
- Set LCD contrast.
- Error log accessible from the processor module or status reporting software.
- Individual dimmer reporting enable/disable.

DIMMER CONFIGURATION

Configuration items associated with the dimmer module can be set from the processor module front panel.

- The output response profile can be set to Linear, Square, S-Curve, Fluo- Electric (for electronic fluorescent ballasts), Fluo-Magnetic (for magnetic fluorescent ballasts), and Non-Dim. The two fluorescent settings let you set the top end voltage and the bottom end cutoff voltage. The Non-Dim setting lets you set the turn-on threshold for the non-dim. Five additional user programmable profiles are available through the Set Rack Configuration menu or from the optional status reporting software.
- Dimmer response (per dimmer): fast (30ms), normal (100ms), slow (300ms), very slow (700ms) or Glacial (1000ms). This determines a dimmer's rate of response to a change in control level. Slow is usually set for large tungsten loads to reduce filament inrush, medium or fast for small loads.

- Dimmer control assignment (per dimmer) to the “combined” levels of Vision.Net, DMX512 A, DMX512 B, Network or to a fixed level (0% - 99% orFull). The way in which the various input levels combine is also determined on a per dimmer basis by setting the dimmer DMX512 mode.
- A special smoothing algorithm is applied to small level changes to maintain smooth fades with long fade times.

CONTROL INPUTS

The Control Interconnection Card, or CIC, is the printed circuit board on which all contractor control wiring connections are made. It is located on the top of the Rack Processor Housing (RPH) and contains:

- An Ethernet switch which connects to a Strand ShowNet system. This switch allows for easy connections between dimmer racks. It also connects to the network receptacle located in the upper left rear of the dimmer rack.
- Two optically isolated DMX512 control inputs. Both inputs can be configured as a DMX512 input, DMX512 output. Each DMX512 input has a patch to allow overlapping or separation of any DMX512 control level.
- Dedicated Strand Lighting Vision.net architectural protocol input/output. This can be set to ‘bridge’ commands to and from Vision.net-over-IP.
- Six optically isolated contact inputs, for:

PIN	FUNCTION	TYPE	DESCRIPTION
1	PANIC ON	Momentary	Turns Panic On
2	PANIC OFF	Momentary	Turns Panic Off
3	FIRE ALARM	Maintained	Turns Panic On, No Override
4	RESERVED	Momentary	Reserved for future use
5	RESERVED	Momentary	Reserved for future use
6	RESERVED	Momentary	Reserved for future use
7	COM/GND		COM/GND
8	COM/GND		COM/GND

- An Audio Visual Interface port. This serial input will support connection to an external A/V or show control system that supports an RS232 serial connection.
- 96 Panic Select switches

SAFETY FEATURES

In order to minimize the impact of failures to any part of C21/EC21 dimmer racks, a number of security features, some of which are optional, are provided.

Standard safety features for C21/EC21 dimmer racks include:

- Convection cooling of all components with fan assist.
- Module over-temperature shutdown (Reporter modules only).
- The processor module can be set to hold the last dimmer levels forever, or to fade to a specified preset in cases of DMX512 signal failure.
- Setup data is stored in non-volatile RAM.
- 2500V optical isolation of DMX512 A and DMX512 B inputs, architectural control communication.
- All, or selected dimmers in a rack can be set to either Off or full On when the external Panic button is pressed.
- Automatic Panic on removal of processor module. In racks with two processor modules, both modules must be removed to activate Panic.
- Password-protected menu lock.

Optional safety features for C21/EC21 dimmer racks include:

- Redundant tracking backup (requires a second processor module fitted to the rack). The backup processor automatically tracks the master processor and takes over control of the dimmer rack on failure of the master processor.

VISION.NET

Vision.Net is a comprehensive family of control stations designed for architectural applications needing a simple, flexible control solution with minimal installation and cabling costs. These control stations can access, modify, and recall lighting levels stored in the rack processor module. Vision.Net control station features and options include:

- Control up to 255 separate rooms, with up to 125 channels per room
- 32 preset scenes available for each room
- Manual sliders (3, 6, 9, or 15 sliders per station) for direct control of individual circuits
- Record facility for saving slider levels for future push-button recall
- Programmable fade times between 0 and 60 minutes from Vision.Net control stations
- Record lockout facility for playback-only operation
- Preset stations available from 1-button up to 8-buttons
- Audio-visual interface
- Room combine stations for room partitioning
- Photo sensor and motion sensor

PROGRAMMING THE DIMMER RACK

CONTROLS AND DISPLAYS

You can access the range of C21 / EC21 dimmer rack programmable features using the Jog Wheel and LCD display. Menus are shown in English.

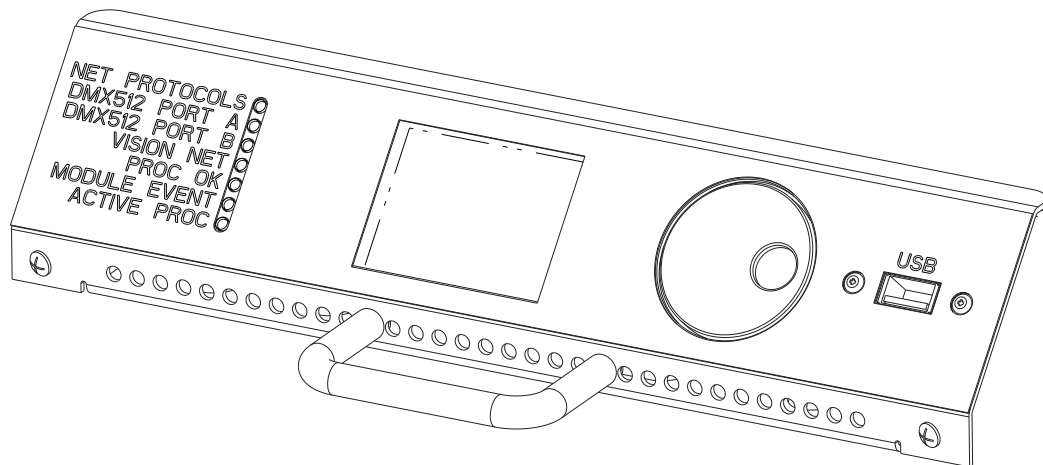

FIGURE 8. RACK PROCESSOR MODULE FRONT PANEL

LOCK MENU

To avoid accidental or unauthorized use, you can lock the menu. When Lock Menu is enabled, the menu is locked immediately. When disabled, the menu is unlocked.

To unlock the Menu:

Press the jog wheel for >10 seconds. At prompt, enter passcode to unlock the menu.

NAVIGATING THE MENU

Turning the jog wheel clockwise is considered to be a 'forward' motion, and counter-clockwise (anti-clockwise) is a 'backward' motion. Move the jog wheel forward to advance through the menu or increase selected value. Move the jog wheel backward to reverse through the menu or decrease a selected value.

Pressing the knob is considered to be a 'select' command. Selecting a menu will drill down into a sub-menu, and selecting a value will toggle the ability to edit it. While a value is editable it will appear as red text, and when not-editable it will appear with an underline as a cursor.

THE MAIN MENU

The main menu lets you access all the other menus for configuring C21/EC21 dimmer racks.

To access the main menu:

From any of the status displays, Press [**<**] or [**>**]

To return to the main menu

Press [**ESC**]

NOTE: If no dimmer event is registered, returning from the main menu brings you back to the display from which you called the main menu. If a dimmer event is registered you will return to the dimmer events display.

RACK IDENTITY MENU

The Rack Identity menu allows you to configure the following settings for the dimmer rack:

VIEW RACK NAME. View or edit the name of the dimmer rack in this text field. Rack name shows on the second line of the display.

VIEW RACK LOCATION. View or edit the location of the dimmer rack in this text field.

VIEW MAIN BREAKER ID. View or edit the name or location of the main breaker in this text field.

VIEW SERIAL NUMBER. View the C21/EC21 Processor serial number. The serial number is entered by the factory and should not be changed in the field.

VIEW DEALER INFO. View Dealer Information text field. The information for this text field is entered within the Factory Menu section.

SET DATE. View or edit the date field. Format: MM/DD/YY

SET TIME. View or edit the time field. Format: 24-hour (HH:MM:SS)

VIEW RACK SIZE. View the rack size (slot and dimmer count). The rack size is set in the Factory Menu section. Default: 48 slot 96 Dims

VIEW SOFTWARE VERSION. View the current software version of the rack processor.

NETWORK CONFIG MENU

The Network Config menu allows you to configure the following settings for the network settings of the dimmer rack:

SET IP ADDRESS. Enter the IP address for the rack processor. Default IP address is 192.168.0.72.

NOTE: Every rack processor is set to this default IP address. Make sure to create a unique number for each dimmer rack in the system prior to adding the racks to the network.

SET SUBNET MASK. Set the SubNet Mask for the rack processor. Default SubNet Mask is 255.255.255.0.

NOTE: The default subnet Mask should not be changed unless instructed to do so by Strand.

VIEW HOST NAME. View the Host Name for the processor.

NOTE: This field is the name seen on the network and is different than the dimmer rack name created in the Rack Identity Menu.

SET GATEWAY IP. Set the Gateway IP address for the processor. The default Gateway IP is: 192.168.0.1.

NOTE: The default Gateway IP address should not be changed unless instructed to do so by Vari-Lite.

VIEW MAC ADDRESS. View the MAC Address assigned to the C21 and EC21 processor. The MAC address is set at the factory is not accessible.

IP PROT SUBNET. Used to modify the active Art-Net subnet.

RACK CONFIG MENU

Rack Config Menu allows you to set the configuration of the dimmer rack.

VIEW MODULE TYPES. Review the dimmer module type assigned to the dimmer slots, 6 dimmers at a

time.

SET MODULE TYPE. Set a single dimmer module type (based on the module part number) for each rack slot.

SET MODULE TYPE RANGE. Set the module type (based on the module part number) for a range of dimmer rack slots.

SET FAN CONTROL. Adjust the minimum fan speed.

SET LCD BACKLIGHT. View or edit the LCD backlight.

LOCK MENU. Enable or disable the keypad lockout.

SET PREFERRED PROCESSOR. Allows you to select which processor, main or backup, will be active.

FORCE ACTIVE PROC. Tells the Rack Mount Processor which Processor Module is currently driving the simmer outputs.

ENABLE CABLE COMP. Enable or disable cable compensation.

ENABLE VOLTLOSS COMP. Enable or disable voltage loss compensation.

SAVE CONFIG TO USB. Save the current processor configuration as a recovery file on the USB drive.

DOWNLOAD CFG FROM USB. Restore the saved configuration file from the USB drive.

SAVE CFG TO EEPROM. Save the current processor configuration to the removable Control Interconnection Card (CIC) EEPROM.

RESTORE EEPROM CFG. Restore the current processor configuration to the removable Control Interconnection Card (CIC) EEPROM.

UPDATE FIRMWARE. Used to update the firmware on all processors in the system. Note that if there is a backup main processor this will need to be updated separately.

CHANGE PASS CODE. Create a 4-digit pass code for secured menu items.

NOTE: The Default pass code of “2606” is always enabled and cannot be changed.

USER PROFILE MENU

The User Profile Menu View allows you to view and create the five user-defined dimming curves.

SET USER PROFILE. View or edit five user-defined dimmer profiles (dimming curves) that may be applied using the Select Profiles function under the Dimmer Config menu. You can set the input and output values for up to 100 steps for each user profile.

DIMMER CONFIG MENU

Dimmer Config Menu allows you to set the configuration the dimmer modules and the priority of the discrete signals.

SET DIMMER PATCH. Allows you to assign ranges of dimmers to listen to net-slots at various priority or HTP levels. The table below shows the three default patches.

	DIMMERS	NSLOT	PRI
001	01-96	00001	01h
002	01-96	05121	02h
003	01-96	05633	03h

- Column #1 Lists the number of the patch
- Column #2 - Dimmers Lists the range of dimmers assigned to the patch.
- Column #3 - Nslot (Netslot) Lists the start number of the range
- Column #4 - Pri (Priority) Lists the priority number and if it is assigned as HTP

NOTE: By default all possible dimmers are assigned. Generally this number will reflect the actual number of dimmers in the rack.

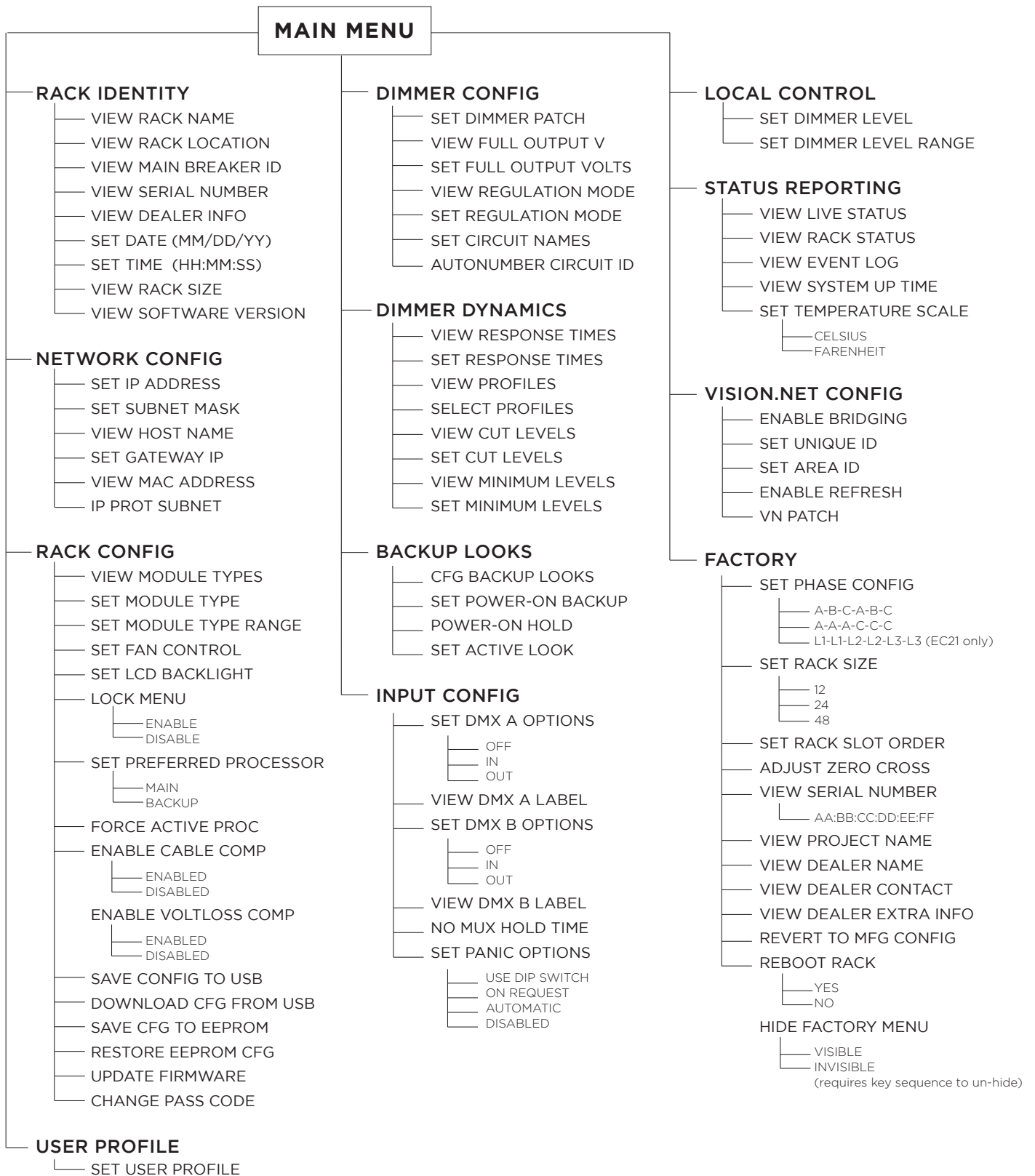

VIEW FULL OUTPUT V. View the Maximum output voltage of the dimmers, six at a time.

SET FULL OUTPUT VOLTS. Set the Maximum output voltage for any range of dimmers in the rack. For instance, you can set the maximum voltage lower than the rated voltage of your lamps for improved lamp life. If you have lamps or other equipment which operate at a lower line voltage, you can set the output from the dimmer to an appropriate voltage for the devices.

The maximum output voltage is applied to all dimmers and dimmers assigned as non-dims. It is not applied to contactor non-dims. You cannot use contactor non-dims for devices which need a maximum output voltage setting.

NOTE: This function sets the dimmer output voltage, not the maximum control level applied to the dimmer.

CAUTION! Be careful when using a maximum output voltage with dimmers set for PANIC. When panic is activated, full output voltage appears at the output of any dimmer or non-dim set for PANIC, regardless of how the maximum output voltage is set.

VIEW REGULATION MODE. View the dimming curve assigned to a range of dimmers, 6 dimmers at a time.

SET REGULATION MODE. Set the Regulation Mode for a range of dimmers. These options are:

ThReg = Thyristor dimmer regulated

ThUnr = Thyristor dimmer unregulated

N-Dim = Non-Dim

SiReg = SineWave regulated

SiUnr = SineWave unregulated

IGBT = IGBT dimmers must be configured to this setting

SET CIRCUIT NAMES. View or edit the Circuit ID number for individual dimmers.

AUTONUMBER CIRCUIT ID. Automatically assign sequential circuit ID numbers to the dimmers.

DIMMER DYNAMICS MENU

The Dimmer Dynamics Menu allows you to view and configure dimmer information.

VIEW RESPONSE TIMES. View the response times for the dimmers, six dimmers at a time.

SET RESPONSE TIMES. The response time of a dimmer is the rate at which it responds to increases or decreases in the control level. C21 / EC21 dimmer racks provide five response times:

Fast = 30ms Slow = 300ms Glacial = 1000ms Normal = 100ms Very Slow = 700ms

These options can be applied to a single dimmer or a range of dimmers. Slow is generally used for large lamp loads, while fast is used for smaller lamp loads that might be used in a chase effect.

NOTE: The “fast” setting, together with the accuracy of digital dimmers can cause very high inrush current.

CAUTION! Do not use “fast” for IGBT dimmers or lamps that are 5kW or higher.

VIEW PROFILES. Allow you to view the dimming curve for the dimmers, six dimmers at a time.

SELECT PROFILES. Allows you to select the dimming curve for a range of dimmers:

SqLaw = Square Law

Old SqLaw = Legacy Square Law curve

S-Crv = S-Curve

Old S-Crv = Legacy S Curve

LinPw = Linear Power

N-Dim = Non-Dim

FIEle = Fluorescent Electronic

FIMag = Fluorescent Magnetic

MarkX = Advanced Mark X Ballasts

User1 = User Defined Dimming Curve #1

User2 = User Defined Dimming Curve #2

User3 = User Defined Dimming Curve #3

User4 = User Defined Dimming Curve #4

User5 = User Defined Dimming Curve #5

VIEW CUT LEVELS. View the Cut Levels for the output dimmers, up to 6 at a time.

SET CUT LEVELS. Set the Cut Levels for the output dimmers. Note that the cut level is the percentage at which, below this number, the output will automatically be set to '0' instead.

VIEW MINIMUM LEVELS. View the minimum dimmer output level, 6 dimmers at a time.

SET MINIMUM LEVELS. Set the minimum dimmer output level for a range of dimmers.

Set a minimum level for any or all the dimmers. This can be used for security or safety lighting in locations where a minimum light level is required under all circumstances. This function can also be used as a preheat for large lamps.

Minimum levels are displayed in control percentages.

NOTE: This function sets the minimum control level applied to the dimmer, not the minimum output voltage.

BACKUP LOOKS MENU

CFG BACKUP LOOKS. Configure the Looks dimmer by dimmer.

SET POWER-ON BACKUP. Configure which Look is automatically shown if there are no control signals at power-up.

POWER-ON HOLD. Selects how long the Power-On Backup Look is enabled. Choices are Off, 00:01, 00:10, 00:15, 01:00, 24:00, Forever.

SET ACTIVE LOOK. Manually activate or deactivate one of the 8 configurable Looks. Note that this will override any incoming control signals until deactivated.

INPUT CONFIG MENU

Input Config Menu allows you to view and set the Mux A and Mux B ports.

SET DMX A OPTIONS. Set the DMX512 A port:

Off = Turns the DMX512 A port off

In = Define the net-slot range for the DMX512 A port. (Default: In 5121)

Out = Define the net-slot range of output for the DMX512 B port.

VIEW DMX A LABEL. View a label for the DMX512 A port.

SET DMX B OPTIONS. Set the DMX512 B port:

Off = Turns the DMX512 B port off

In = Define the net-slot range for the DMX512 B port.

Out = Define the net-slot range of output for the DMX512 B port. (Default: Out 5633)

VIEW DMX B LABEL. View a label for the DMX512 B port.

NO MUX HOLD TIME. Set the Hold Time for the last-used dimmer outputs when all input control signals have disappeared.

SET PANIC OPTIONS. Options are Use DIP Switch, On Request, Automatic, Disabled

LOCAL CONTROL MENU

SET DIMMER LEVEL. Set an individual dimmer to INPUT or to a local level between 0% and FULL.

NOTE: Setting dimmer levels to something other than INPUT overrides the control inputs, including presets, you can easily loose control of dimmers by forgetting to set them back to INPUT. The levels set in this menu are remembered even when you shut down the rack.

You can use the Set Dimmer levels menu to set dimmer levels in order to record Backup Looks where there is no conventional lighting control system.

SET DIMMER LEVEL RANGE. Set a range of dimmers to INPUT or to a local level between 0% and FULL.

NOTE: Setting dimmer levels to something other than INPUT overrides the control inputs, including presets, you can easily lose control of dimmers by forgetting to set them back to INPUT. The levels set in this menu are remembered even when you shut down the rack.

You can use the Set Dimmer levels menu to set dimmer levels in order to record Backup Looks where there is no conventional lighting control system.

STATUS REPORTING MENU

VIEW LIVE STATUS. View the Reporting Status of reporting modules. This can show temperature, errors, current dimmer level, voltage, current draw and power consumption.

VIEW RACK STATUS. View the status of the Rack. This shows the three input Phase Voltages, Line Frequency, Rack Temperature, Fan Speed and number of dimmers.

VIEW SYSTEM UP TIME. View how long the system has been up without any resets or power cycles.

SET TEMPERATURE SCALE. Select Celsius or Fahrenheit.

VISION.NET CONFIG MENU

ENABLE BRIDGING. Enabling this will forward packets from the dedicated Vision.net Port to Vision.net-over-IP and vice-versa. Default is Disabled.

SET UNIQUE ID. Sets a Unique ID for this system. Default ID is 0.

SET AREA ID. Sets the Vision.net Area to which this rack listens. Default is 1.

ENABLE REFRESH. When enabled, this system will request the current state of the Vision.net system. Default setting is Off.

VN PATCH. View or Change the Vision.net room and channel patch per dimmer.

FACTORY MENU

The Factory Menu configurable options are installation-specific which, once set, are not likely to ever change.

SET PHASE CONFIG. Configure between Single Phase and Three-Phase.

A-B-C-A-B-C

A-A-A-C-C-C

L1-L1-L2-L2-L3-L3 (EC21 only)

SET RACK SLOT ORDER. Configure whether the modules are labeled Horizontally or Vertically.

ADJUST ZERO CROSS. Configure the phase shift from zero-crossing to prevent the dimmer outputs from flashing (in microseconds).

VIEW SERIAL NUMBER. Serial number format: AA:BB:CC:DD:EE:FF

VIEW PROJECT NAME. View the Project Name.

VIEW DEALER NAME. View the Dealer Name.

VIEW DEALER CONTACT. View the Dealer Contact.

VIEW DEALER EXTRA INFO. View extra Dealer Info.

REVERT TO MFG CONFIG. Resets the configuration to factory defaults.

C21 / EC21 WEB PAGES

This section provides basic information on the C21/EC21 Web Pages.

MAIN SCREEN

STATUS

Select [STATUS] to gain access to the following options:

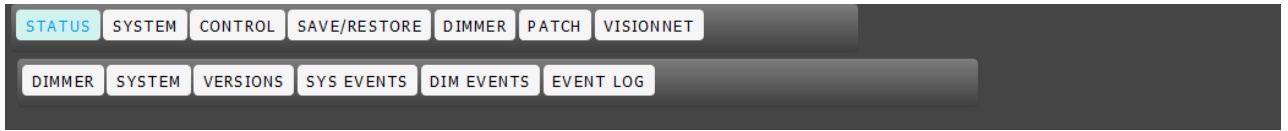

STATUS > DIMMER

STATUS > SYSTEM

STATUS > VERSIONS

STATUS > SYS EVENTS

STATUS > DIM EVENTS

STATUS > EVENT LOG

SYSTEM

Enter Password:

Strand C21 / EC21
 Advanced Control Electronics

NAME	Mine	UPTIME	2 days, 0:43	EVENTS	None	ACTIVE LOOK	None
NETWORK STATUS	Up	DMX A	DMX In - Inactive	DMX B	DMX Out - Inactive	PANIC STATUS	Off
TEMPERATURE (°F)	75	FAN SPEED (%)	25	DATE/TIME	2019-11-06 13:04:48		
MAINS VOLTAGE	120, 120, 120	MAINS FREQUENCY (HZ)	60	ACTIVE PROCESSOR	Yes		
MAIN PROCESSOR	Ready	BACKUP PROCESSOR	Not Present	PRIVILEGED	No		

Select [SYSTEM] to gain access to the following options:

SYSTEM > PARAMETERS

DIMMER	CIRCUIT	LEVEL (%)	OUTPUT (V)	CURRENT (A)	TEMP Â°F	MODULE TYPE	ERROR	REGULATION	SOURCE
1	1	0	N/R	N/R	N/R	0	None	Thyristor, Regulated	IP Protocols
2	2	0	N/R	N/R	N/R	0	None	Thyristor, Regulated	IP Protocols
3	3	0	N/R	N/R	N/R	0	None	Thyristor, Regulated	IP Protocols

Main
 30
 ●●●●
 130.146.59.94
 255.255.255.0
 192.168.1.1
 DMXPort1

SYSTEM > MODULES

The screenshot shows the 'SYSTEM' menu selected. The top navigation bar includes: STATUS, SYSTEM, CONTROL, SAVE/RESTORE, DIMMER, PATCH, VISIONNET. The secondary navigation bar includes: DIMMER, SYSTEM, VERSIONS, SYS EVENTS, DIM EVENTS, EVENT LOG. The main content area displays a table of hardware specifications:

SERIAL NUMBER	38:D2:69:39:9B:EC
MEMORY SIZE (MB)	234
MEMORY AVAILABLE (MB)	151
FLASH STORAGE SIZE (MB)	3586

SYSTEM > DATE/TIME

The screenshot shows the 'SYS EVENTS' menu selected. The top navigation bar includes: STATUS, SYSTEM, CONTROL, SAVE/RESTORE, DIMMER, PATCH, VISIONNET. The secondary navigation bar includes: DIMMER, SYSTEM, VERSIONS, SYS EVENTS, DIM EVENTS, EVENT LOG. Below the navigation are 'ACTIVE' and 'HISTORICAL' buttons. The main content area displays a table of system events:

EVENT	MOST RECENT	COUNT	ACTIVE	ACKNOWLEDGED	SUPPRESSED
DMX A Absent	2019-11-05 17:16:25	1	Yes	No	No

The screenshot shows the 'DIM EVENTS' menu selected. The top navigation bar includes: STATUS, SYSTEM, CONTROL, SAVE/RESTORE, DIMMER, PATCH, VISIONNET. The secondary navigation bar includes: DIMMER, SYSTEM, VERSIONS, SYS EVENTS, DIM EVENTS, EVENT LOG. Below the navigation are 'ACTIVE' and 'HISTORICAL' buttons. The main content area displays a table of dimmer events:

CIRCUIT	EVENT	MOST RECENT	COUNT	ACTIVE	ACKNOWLEDGED	SUPPRESSED
15	Not Reporting	2019-11-06 02:19:53	1	Yes	No	No

Below the table is a date selector showing 'Day' with '6' selected. At the bottom, the 'EVENT LOG' menu is selected, displaying a log for '2019-11.log':

```

2019-11-01 09:27:56 - IP Protocols Absent
2019-11-01 10:35:48 - IP Protocols Absent
2019-11-01 11:18:45 - System Powered Up
2019-11-01 11:18:49 - DMX A Absent
2019-11-01 11:18:49 - DMX B Absent
2019-11-01 11:18:49 - IP Protocols Absent
2019-11-01 11:18:51 - Active Processor
    
```

SYSTEM > CONSTRUCTION

STATUS SYSTEM CONTROL SAVE/RESTORE DIMMER PATCH VISIONNET

PARAMETERS MODULES DATE/TIME CONSTRUCTION BACKUP LOOKS FIRMWARE

Rack Model C21

Mains Voltage Range 90-140

Mains Phase Sequence A-B-C-A-B-C

Rack Size 48

Rack Slot Order Horizontal

Phase Lag 240

Dealer_Name dealer name

Dealer Extra dealer extra

Dealer Contact dealer contact

Project Name project name

Factory Menu Enabled

SYSTEM > BACKUP LOOKS

STATUS SYSTEM CONTROL SAVE/RESTORE DIMMER PATCH VISIONNET

PARAMETERS MODULES DATE/TIME CONSTRUCTION BACKUP LOOKS FIRMWARE

DIMMER	LEVEL
1	10
2	10
3	10
4	10
5	10
6	10
7	10
8	10
9	10
10	10
11	10
12	10
13	10
14	10
15	10
16	10
17	10

SYSTEM > FIRMWARE

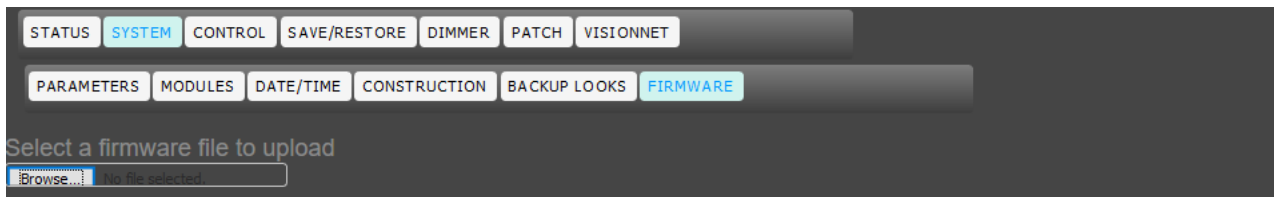

CONTROL

Select [CONTROL] to gain access to the following options:

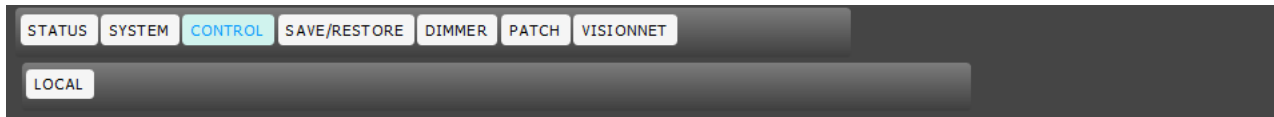

CONTROL > LOCAL

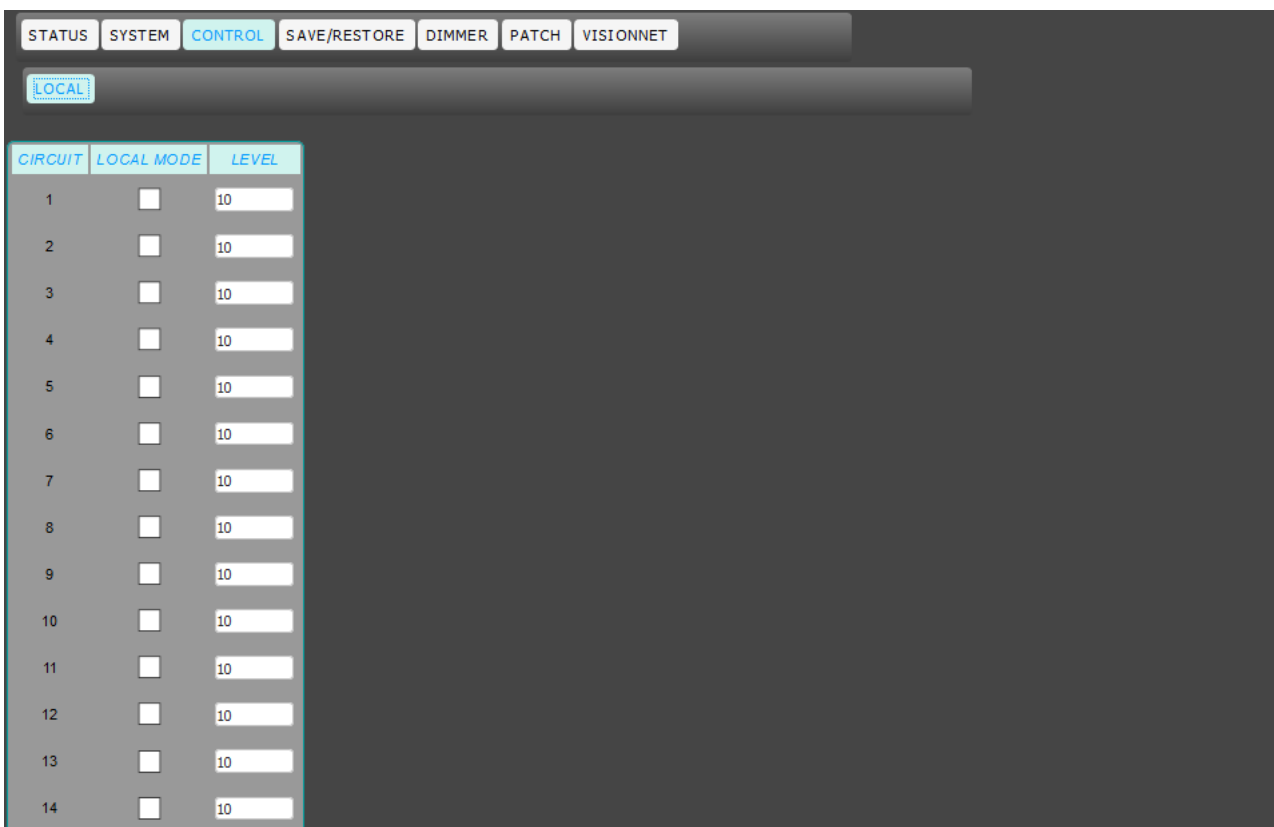

SAVE/RESTORE

Select [SAVE/RESTORE] to gain access to the following options:



SAVE/RESTORE > SAVE BACKUP CFG

Note that this will save the current operating parameters to a backup area on the rack processor, overwriting any previously saved parameters.

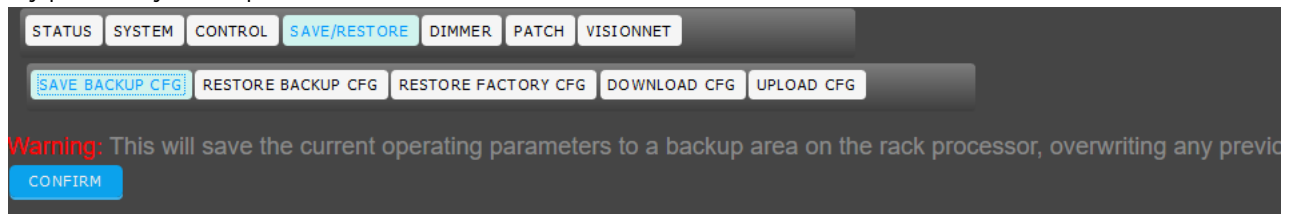

SAVE/RESTORE > RESTORE BACKUP CFG

Note that you will lose all changes made since the last configuration save. The system will restart and revert to the IP address saved in the backup configuration if you accept.

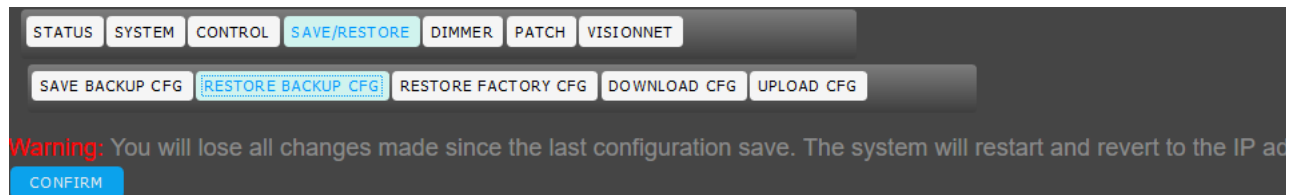

SAVE/RESTORE > RESTORE FACTORY CFG

Note that you will lose the configuration state and need to reconfigure the entire system. The system will restart and revert to the factory assigned IP address if you accept.

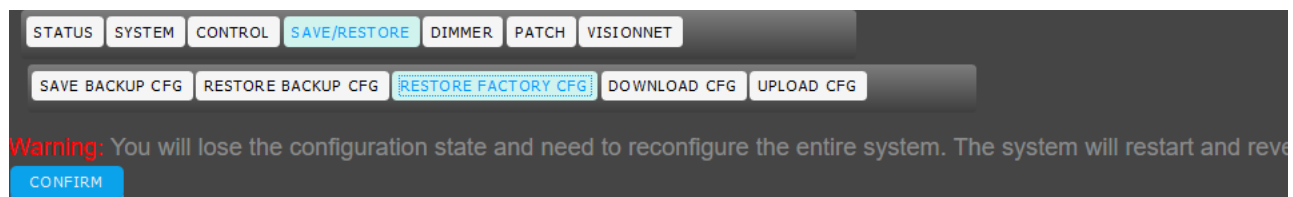

SAVE/RESTORE > DOWNLOAD CFG

Note that this will save the current operating parameters to a file on your computer. You can save multiple copies by modifying the filename the data is saved as.

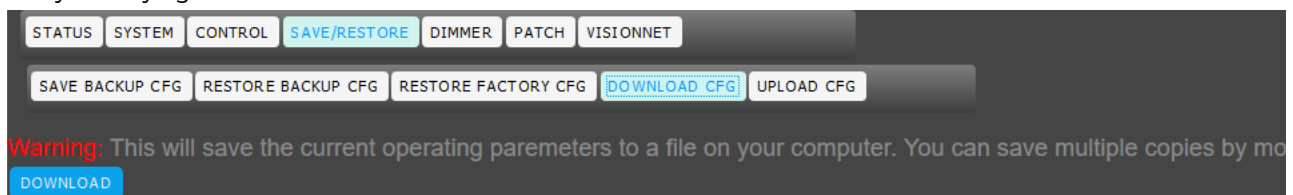

SAVE/RESTORE > UPLOAD CFG

Note that you will lose the current configuration state. The system will restart and will have the IP address contained in the upload configuration file if you accept.

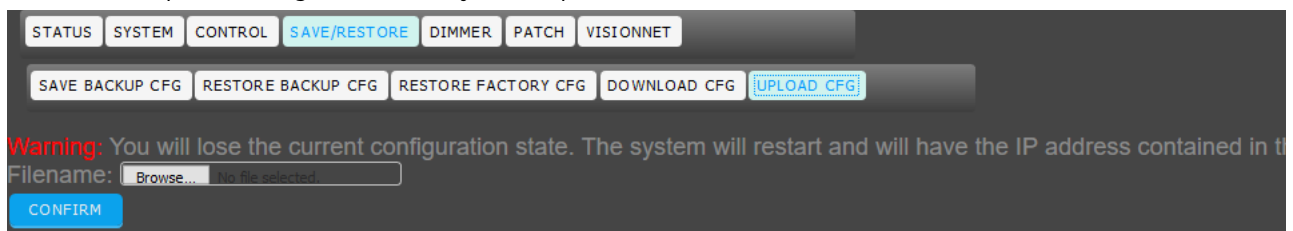

DIMMER

Select [DIMMER] to gain access to the following options:

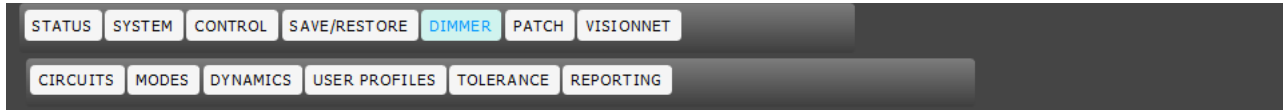

DIMMER > CIRCUITS

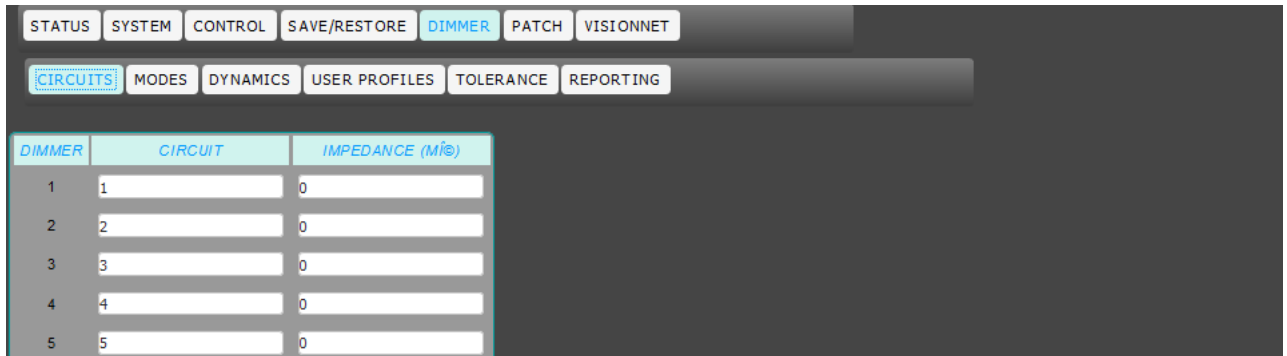

DIMMER > MODES

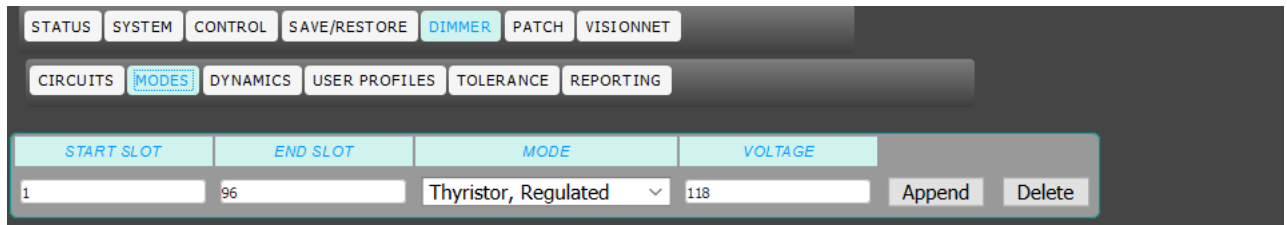

DIMMER > DYNAMICS

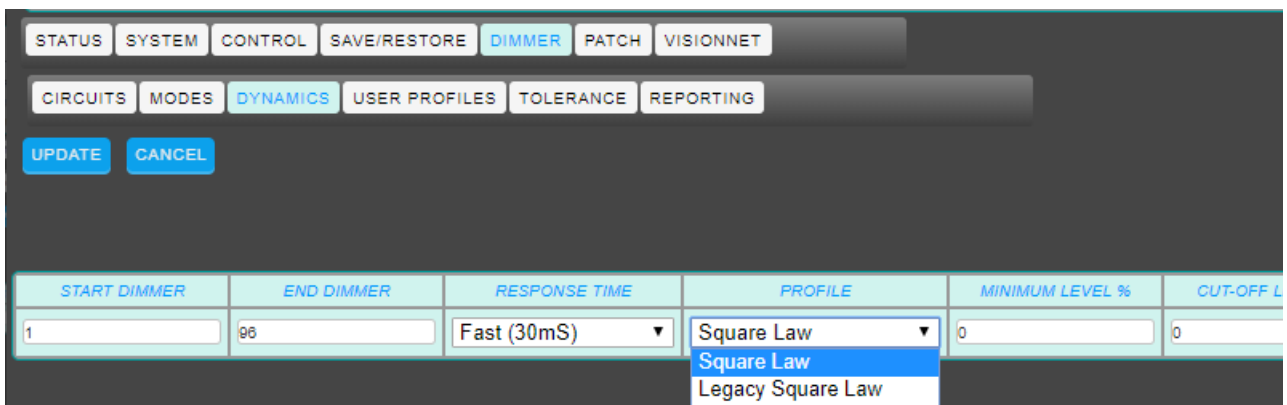

DIMMER > USER PROFILES

DIMMER > TOLERANCE

DIMMER > REPORTING

PATCH

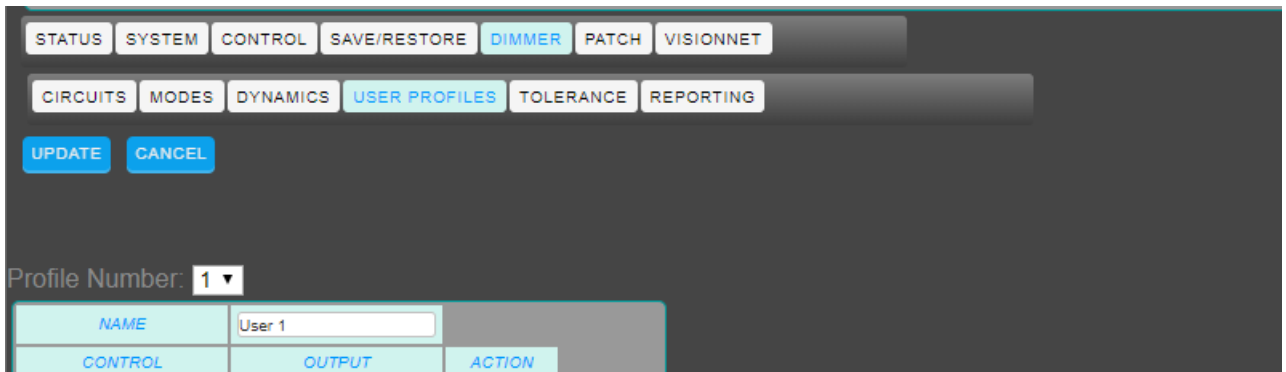

Select [PATCH] to gain access to the following options:

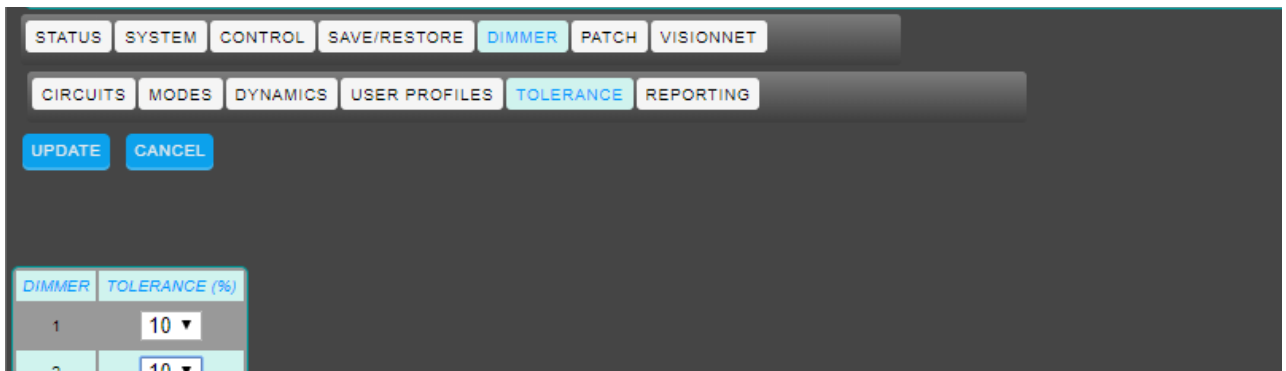

PATCH > DIMMER

Place holder text.

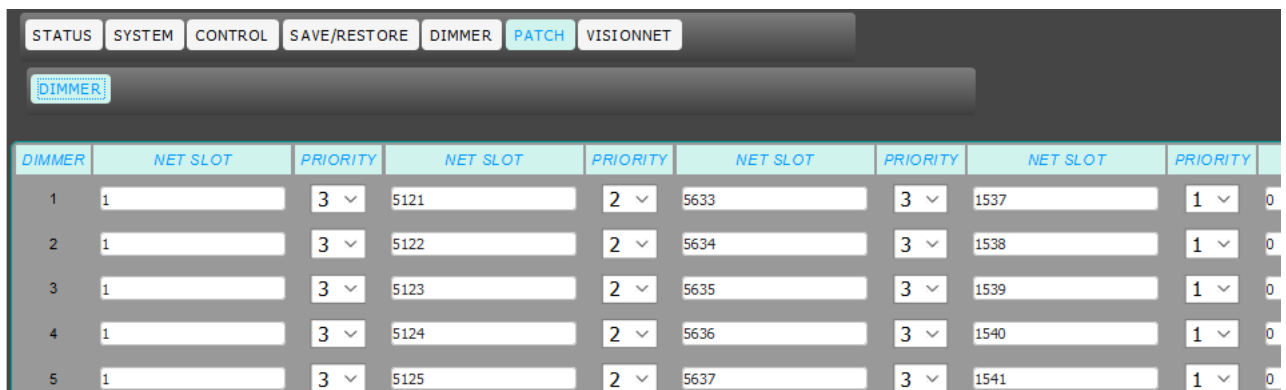

VISION.NET

Select [VISION.NET] to gain access to the following options:

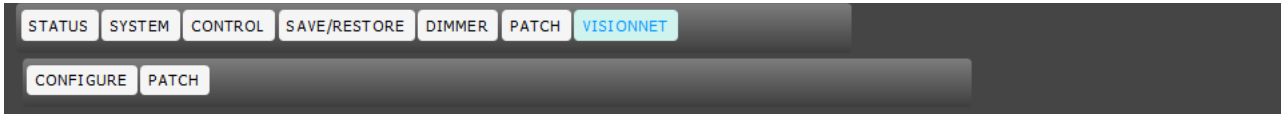

VISION.NET > CONFIGURE

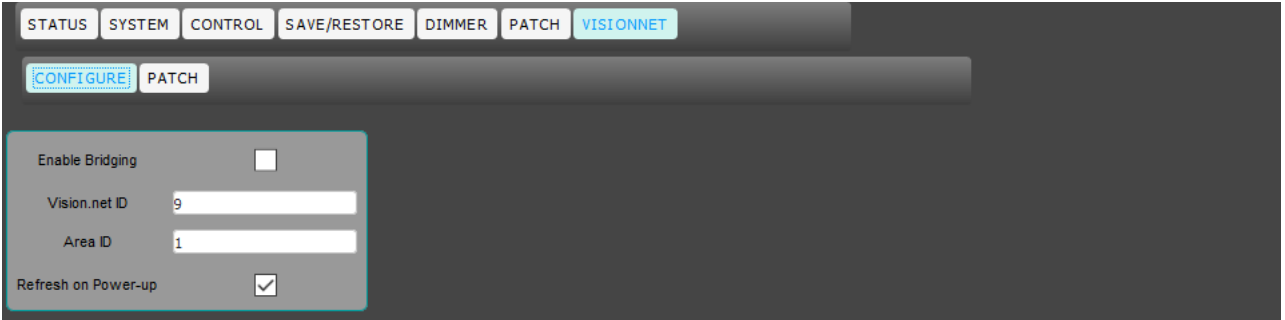

VISION.NET > PATCH

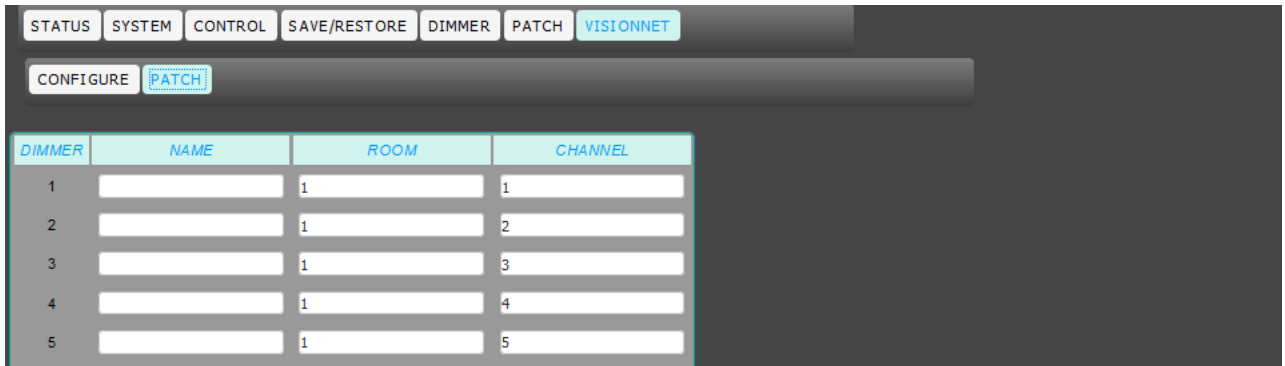

THIS PAGE INTENTIONALLY BLANK

TECHNICAL SUPPORT

GLOBAL 24HR TECHNICAL SUPPORT:

Call: +1 214 647 7880
entertainment.service@signify.com

NORTH AMERICA SUPPORT:

Call: 877-VARI-LITE (877-827-4583)
entertainment.service@signify.com

EUROPEAN CUSTOMER SERVICE CENTER:

Call: +31 (0) 543 542 531
entertainment.europe@signify.com

©2023 Signify Holding. All rights reserved.

All trademarks are owned by Signify Holding or their respective owners. The information provided herein is subject to change, without notice. Signify does not give any representation or warranty as to the accuracy or completeness of the information included herein and shall not be liable for any action in reliance thereon. The information presented in this document is not intended as any commercial offer and does not form part of any quotation or contract, unless otherwise agreed by Signify. Data subject to change.

C21 / EC21 OPERATION GUIDE

Document no.: 2-450174-030A

Version date: March 23 2023